

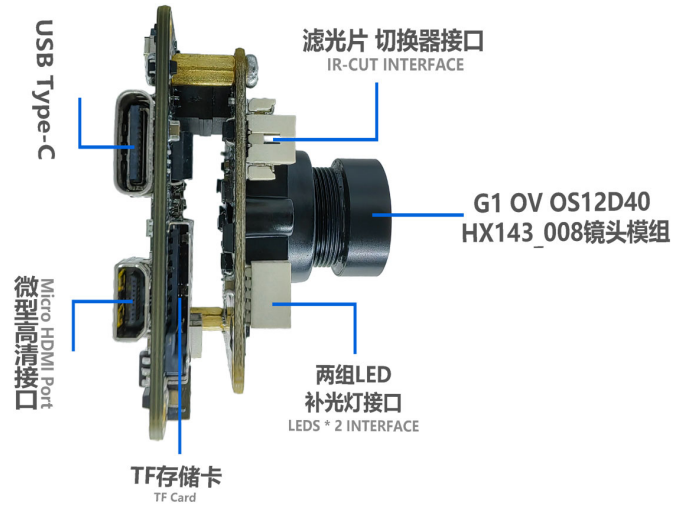

YDS-G1M9+YDS-CMFL143008-OS12D40 V1.0

Ai Master Board + 11.3MP OmniVision OS12D40 Fixed Focus Camera Module Development Kit

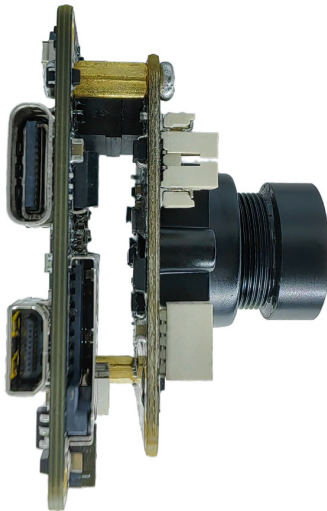

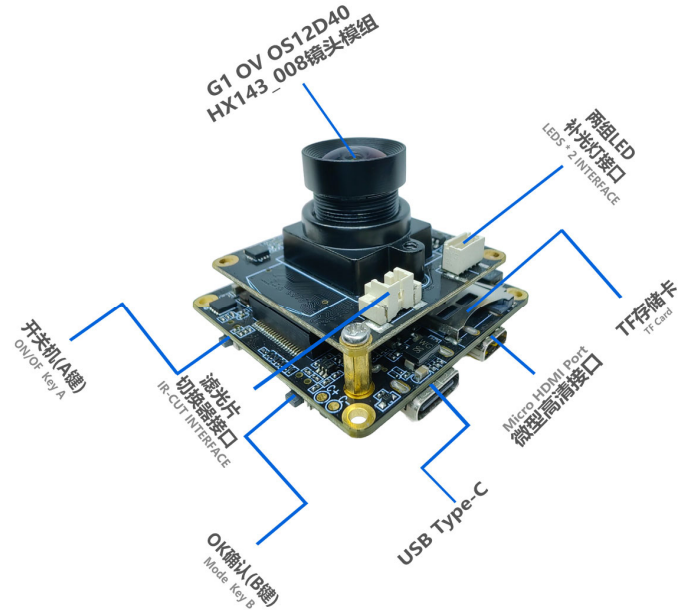

YDS-G1M9+YDS-CMFL143008-OS12D40 V1.0 Ai Master Board + 11.3MP OmniVision OS12D40 Fixed Focus Camera Module Development Kit

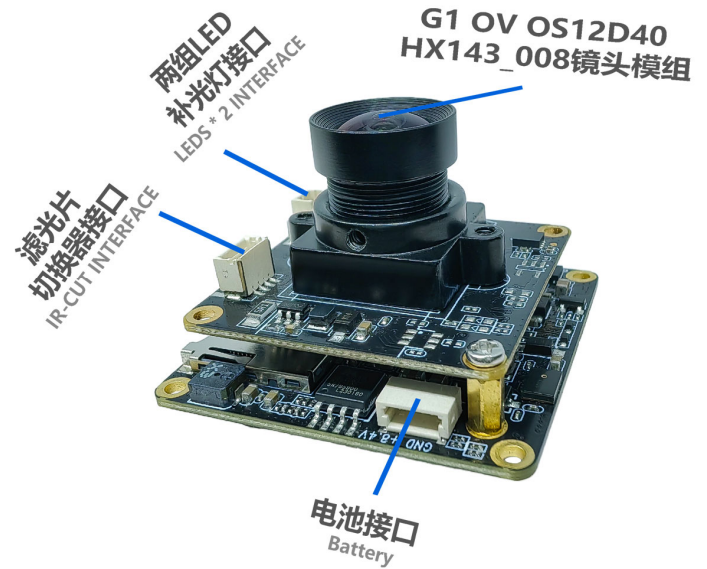
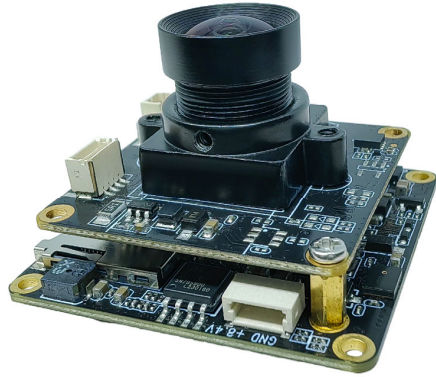

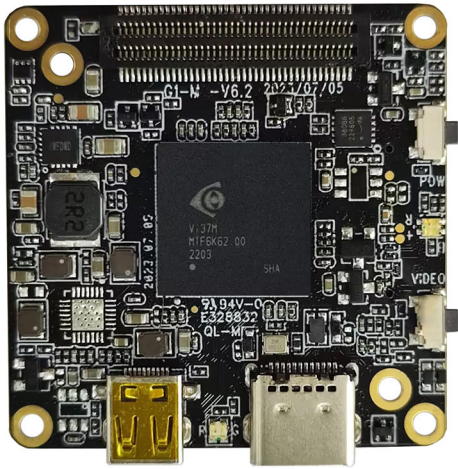
YDS-G1M9 V6.2**iCatch V39 Ai-Powered Image Processing SoC Master Board**

Front View

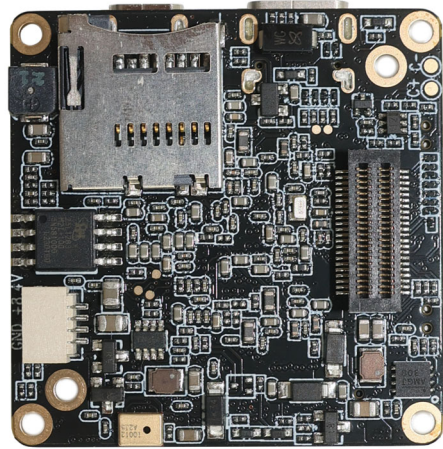

Back View

Overview

Equipped with iCatch V39, built-in 2GB DDR3, supports up to 4K@60FPS (differential), 4K@30FPS, 1080P@120FPS H.264 encoded video. Onboard support Type-C, HDMI, TF memory card, recording, 2 control buttons, buzzer, battery power supply, etc.

This master board extension also supports WiFi, LCD display, CVBS, lens module, UART, I2C, SPI, PWM, MIC and other expansion interfaces. The board size is 38x38mm. Widely used in drones, mini DV, wearable devices, sports cameras, face recognition, USB cameras and other camera products.



YDS-G1M9 V6.2

iCatch V39 Ai-Powered Image Processing SoC Master Board

Hardware Specifications

Model No.	YDS-G1M9 V6.2
Main Control Chipset (DSP)	iCatch V39
Image Sensor Interface	MIPI
Battery Voltage	7.4V - 7.7V High Voltage Lithium Battery
Storage Type	External TF Card, Supports 8GB - 512GB Class 10 and Above, U3 is Recommended
Type-C Port	Type-C USB 5V Connection to Computer USB Mode Connection to PCCAM (Camera) Mode
LED Indicator Type	Three Color Light (Red, Green, Blue)
2 Control Button Type	Power Button (A), OK Button (B)
Power Supply	Supports 3 Power Supply Methods At The Same Time (1) 5V USB to Type-C Port Power Supply (2) 9V-24V WiFi Board or Network Port board Power Supply (3) 6.8V-8.4V Battery Power Supply (The 3-Axis Gimbal Version Does Not Support 5V USB)
Operating Temperature	-10°C to +60°C Without Housing
Storage Temperature	-20°C to +80°C
Humidity	20% to 80%
PCB Dimensions	38 x 38 mm
PCB Screw Hole Spacing	External (34mm x4), Internal (28mm x2)
PCB Screw Hole Diameter	2 mm
Optional Camera Configuration	(1) YDS-G1M9 V6.2 + Camera (2) YDS-G1M9 V6.2 + Camera + YDS-G1WF V6.3 WiFi Board (3) YDS-G1M9 V6.2 + Camera + YDS-G1NK V6.3 Ethernet Board
Supportive Image Sensors	13MP: IMX258 12MP: IMX377 OS21D40 IMX577 IMX386 IMX378 8MP: IM317 5MP: IMX335 2MP: IMX290 IMX385
Optional Extension Ports	WiFi, Ethernet Network Port, Display, Audio IC, Lens Module, UART, I2C, SPI, PWM, MIC, etc.

YDS-G1M9 V6.2

iCatch V39 Ai-Powered Image Processing SoC Master Board

Photo Image Settings

Resolution	20MP, 13MP, 12MP, 10MP, 8MP, 5MP, 3MP, 2MP
Time Lapse Photography	OFF, 3S, 5S, 7S
Continuous shooting	OFF, 3-Shot, 7-Shot, 15-Shot, 30-Shot
White Balance	Auto, Sunny, Cloudy, Fluorescent, Incandescent
Power Frequency	50Hz, 60Hz
Exposure Compensation	EV 0.0, EV 3.0, EV 7.0, EV 10.0, EV 13.0, EV 17.0, EV 20.0, EV -3.0, EV -7.0, EV -10.0, EV -13.0, EV -17.0, EV -20.0
Time Lapse Photo Interval	OFF, 1S, 2S, 3S, 4S, 5S, 6S, 7S, 8S, 10S, 13S, 15S, 20S, 25S, 30S, 40S, 1min
Time Lapse Duration	No Limit, 1min, 3min, 5min, 10min, 20min, 30min, 1hr, 2hr, 3hr, 5hr
Photo Time Watermark	OFF, Date, Date and Time

Wifi、显示屏、网口、uart、PWM等扩展接口

For Wifi, Display, Network, uart, PWM Etc.

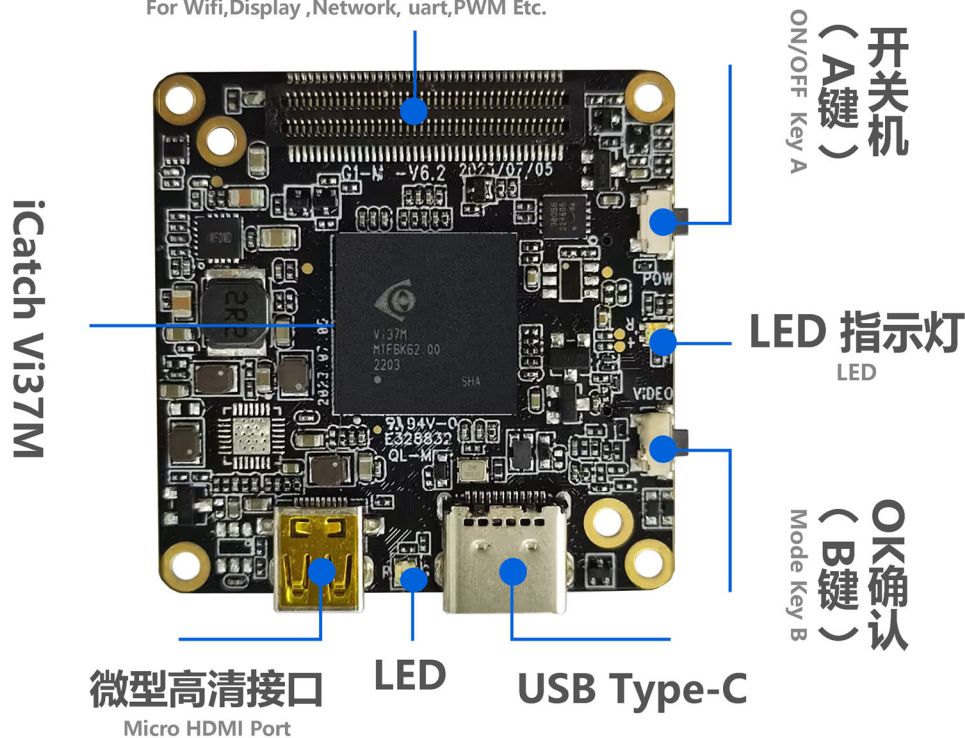



YDS-G1M9 V6.2

iCatch V39 Ai-Powered Image Processing SoC Master Board

Video Settings

Resolution	16:9 (4K, 2.7K, 1080P, 720P) 4:3 (1440P) Currently Only IMX377 Sensor Supports 1440P
Frame Rate	24FPS, 25FPS, 30FPS, 48FPS, 50FPS, 60FPS, 120FPS, 240FPS
Slow Motion Recording	OFF, 4K2X, 1080P4X, 720P8X
Fast Motion Recording	OFF, 2X, 5X, 10X, 15X, 30X
Automatic Recording	OFF, ON
Time Lapse Video Mode	OFF, 1S, 2S, 3S, 4S, 5S, 6S, 7S, 8S, 10S, 13S, 15S, 20S, 25S, 30S, 40S, 60S
Time Lapse Duration	No Limit, 1min, 3min, 5min, 10min, 20min, 30min, 1hr, 2hr, 3hr, 5hr
Pre-recording	OFF, ON (for Option ON, 5 Seconds of Video is Pre-recorded)
EIS Anti-Shake	OFF, ON
Image Quality Enhancement	Super Good, Very Good, Normal (Referral to Actual Video Effect Quality, Not for Preview)
Image Rotation	Normal, Vertical, Horizontal (for Recorded Video)
Recording Time	No Limit, 1min, 5min
Automatic Screen Off	OFF, 60S, 180S, 300S
Light Metering Mode	Center, Multi-point, Single Point
Video Recording File Time	No Limit, 1min, 5min
Loop Recording	OFF, ON
Recording Volume	0, 1, 2, 3
Video Time Watermark	OFF, Date, Date and Time



YDS-G1M9 V6.2

iCatch V39 Ai-Powered Image Processing SoC Master Board

System Settings

Automatic Shut Down	OFF, 1min, 3min, 5min, 10min, 15min
USB Auto Power On	Turn ON, Turn OFF
Languages	English, Simplified Chinese, Traditional Chinese (Select Language Through Configuration File in the Card)
Button Touch Tone	Turn ON, Turn OFF
Automatically Turn On WiFi	Turn ON, Turn OFF
WiFi Frequency Bands	2.4GHz or 5GHz (Dual Band Single Channel)
Display Brightness	Low, Medium, High Brightness (for Touch Screen)
Display Setting	Conventional Display, Full Screen Display (for Touch Screen)
Fill Light A (White Light)	Auto, OFF, ON (for Use with Fill Light Board)
Fill Light B (Infrared Light)	Auto, OFF, ON (for Use with Fill Light Board)
IR Cut Settings	Auto, OFF, ON (for Use with IR Cut Function Modules)
Special Effects	Original Image, Black and White, Natural, Negative, Warm Tones, Contrast (for Touch Screen)
White Balance	Auto, Sunny, Cloudy, Fluorescent, Incandescent
Date and Time	Year, Month, Day, Hour, Minute
Format	No, Yes
Reset	No, Yes
Card Information	Displays Video Card Capacity and Free Space
Device Information	Displays Firmware Version

Gimbal Functions and Settings

Gimbal Functions	Centering, Calibration
Sensitivity	Follow Softly, Follow Sensitively
Follow Mode	Full Follow, Heading Follow, Heading and Pitch Follow
Pitch Axis Control	Turn ON, Turn OFF



YDS-G1M9 V6.2

iCatch V39 Ai-Powered Image Processing SoC Master Board

Camera Features

Continuous Shooting	Long Press the OK Button (B) to Shoot Continuously, Release Button to Stop Shooting Continuously
Snapshot	During Recording, Long Press the OK Button (B) to Capture the Video. Release Button to Stop Snapshot
HDMI Output Resolution	4K@30FPS 1080P@60FPS/30FPS 720P@60FPS
Video Start and Stop Function	Short Press the Power Button (A) to Pause or Continue Video Recording
USB Camera Resolution	H.264: 4K@30FPS, 1080P@120FPS, 720P@60FPS (Dependency on Sensor Type and UVC Protocol) MJPG: 5760x3240@10FPS, 4000x3000@10FPS 4K@30FPS, 1080P@30FPS, 720P@30FPS YUY2: 480P@30FPS (Supports Modification of UVC Output on Configurations)
USB Flash Drive	USB Mode when Connected to Computer
Inverted Mode	By Placing a Configuration File in the Card, You Can Modify the Displayed or Captured file and Flip it 180 degrees
WiFi Mode	AP Mode, STA Mode Set WiFi Mode by Putting Configuration Files in the Card or Enter the Menu to Set This Item Through the Touch Screen
Configuration IP Address	By Placing a Configuration File in the Card, You Can Modify the IP and Gateway Address of the Camera. Default is Static IP. Optional on Dynamic IP.
RTSP Video Stream Address	By Placing a Configuration File in the Card, You Can Modify the RTSP video stream address. If There is No Configuration File in the Card, the Default Port is 554.

YDS-G1M9 V6.2

iCatch V39 Ai-Powered Image Processing SoC Master Board

USB Type-C Interface:

This interface supports USB standard 5V power input, which can power the master board and charge the battery (recommended 7.4V-7.7V battery). Connecting to a computer can directly read files in the TF card and use it as a USB flash drive. It can also be used as a PCCAM USB camera.

The USB interface retains one camera control serial port UART3 and one camera debugging serial port UART1 (the serial port function can be used with the G1-USB serial port debugging board).

Connecting to the Computer USB Flash Drive Mode:

Insert the TF card, connect the other end of the USB to the computer, and automatically enter the USB flash drive mode after booting by default.

Connecting to the Computer PCCAM Mode:

Insert the TF card, connect the other end of the USB to the computer, and automatically enter the USB flash drive mode after booting. Short press the OK button (A) to switch to PCCAM camera mode. (Right-click the computer "Computer", click the left button in the pop-up prompt box to enter "Management", "Device Manager", and you can see the name of the camera identified in "Image Device" camera. Open the camera tool "amcap.exe" to see the current device preview screen).

Battery Power Supply:

6.6V (low power shutdown) to 8.8V, 7.4-7.7V high-voltage and high-density batteries are recommended
Special note: the battery power supply can support up to 12V; but this does not include the gimbal version, the stable power supply voltage of the gimbal version is 8V.

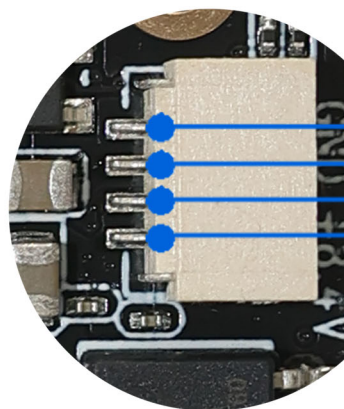
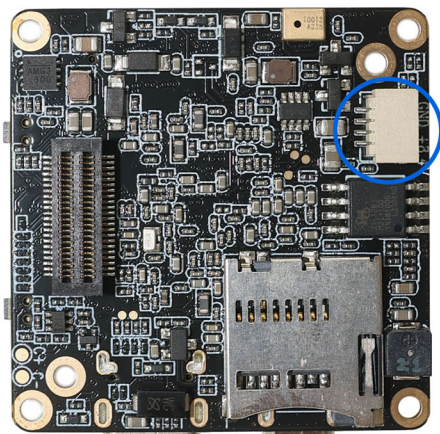

BAT -
BAT +

Battery 7.7V-8.8V
电池供电

YDS-G1M9 V6.2

iCatch V39 Ai-Powered Image Processing SoC Master Board

Charge the Battery:

Use a power adapter (5V2A recommended) to charge the battery of the machine. The red light will be on during charging and the green light will be on when fully charged.

Camera Module:

This interface can be used to expand multiple MIPI sensors, IR-CUT function, LED fill light, serial port UART2, battery power output, micro three-axis gimbal and other functions.

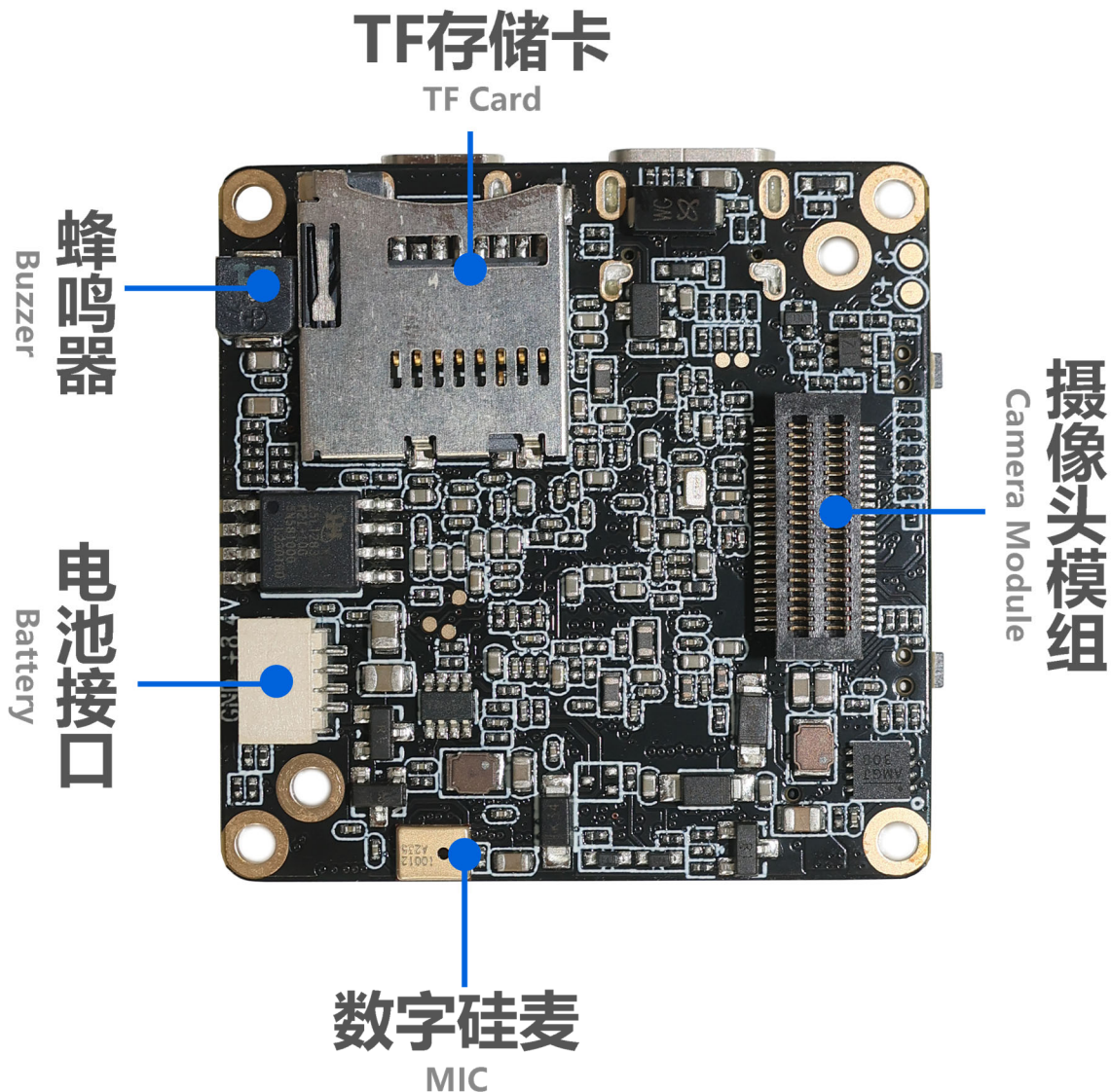



YDS-G1M9 V6.2

iCatch V39 Ai-Powered Image Processing SoC Master Board

Button Instructions:

Button	Mode or Status	Functional Operation
Button A Power Mode	Power ON / OFF	Long Press 1 Second Power ON / OFF
	Standby	Short Press on Switch Mode Video Recording, Snapshot, Playback, Settings
	Setting Mode (with Touch Screen)	Short Press to Scroll Down Menu (After Pressing Button B to Enter Setting)
	Video Recording	Short Press to Pause or Continue Recording
Button B Confirmation OK Video Recording	Standby	In Video Standby Mode, Long Press 3 Seconds to Turn ON / OFF WiFi Mode. Default WiFi is OFF. In Video Recording Mode, Short Press to Start Recording In Snapshot Mode, Short Press to Start Taking Photo Long Press to Start Continue Shooting Release to Stop Continue Shooting
	Video Recording	Short Press to Stop Recording and Save the File Long Press 2 Seconds (Less than 4 Seconds) to Take a Single Frame Shot, Release to Stop Taking Frame Shots Long Press 5 Seconds to Take Continues Frame Shots, Release to Stop Taking Frame Shots
	Setting Mode (with Touch Screen)	Short Press to Confirm and Enter Setting Mode Long Press 2 Seconds to Return Double-Click to Switch Between Settings: Photo / Video / System / 3-Axis Gimbal
	Playback Mode (with Touch Screen)	Short Press to Scroll Up Menu Double-Click to Play / Pause Video or Audio Files Click 3 Times to Mark or Unmark Files. If File is Marked, then the File is Locked and Not Erasable Long Press to Prompt Option to Delete Current File (Long Press to Delete, Short Press to Return) After Entering, Long Press Again to Delete
	Shutdown	Press and Hold to Enter the USB Burning Mode
Reset Function	Standby or Working	Press Button A and B at the Same Time to Shutdown



YDS-G1M9 V6.2

iCatch V39 Ai-Powered Image Processing SoC Master Board

LED Indicator Description:

Functions	Color	Power On	Video Mode	Video Recording	Photo Mode	Photo Snapshot	Playback Mode	Setting Mode
LED Indicator	Red	Always On	Always On	Flashing			Always On	
	Green				Always On	Flash Once	Always On	
	Blue						Always On	Always On

Note: When the device is powered without a TF card inserted, the function indicator light flashes yellow.

Buzzer Sound Description:

Operation Mode	Power On	Power Off	Switching Mode	Start Video Recording	Start Stop Recording	Photo Snapshot	Menu Setting	Menu Scroll Down	Exit Menu Setting
Buzzer Sound	3 Beeps	5 Beeps	1 Beep	1 Beep	2 Beeps	1 Beep	1 Beep	1 Beep	1 Beep

Special Note: When the touch screen is not in use, you can modify the setting parameters through the configuration file. Put the configuration file, such as "CameraConfig_G1A.ini" (the specific configuration file name will vary depending on the lens module) in the root directory of the TF card, and you can modify the corresponding function options in the configuration file. After saving the changes, shut down the machine and restart it to take effect.

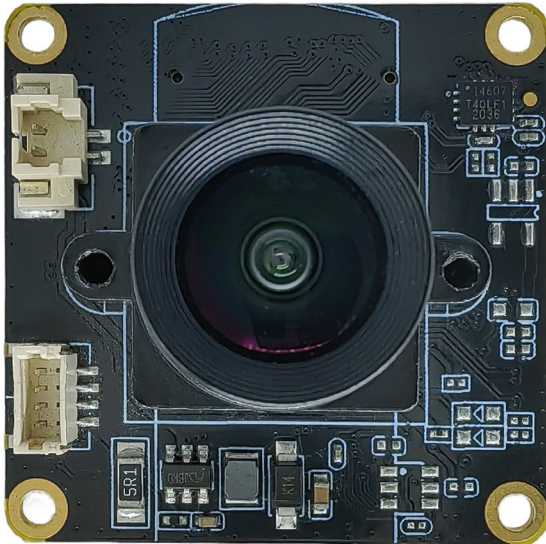
YDS-CMFL143008-OS12D40 V1.0**11.3MP OmniVision OS12D40 Fixed Focus Camera Module**

Front View

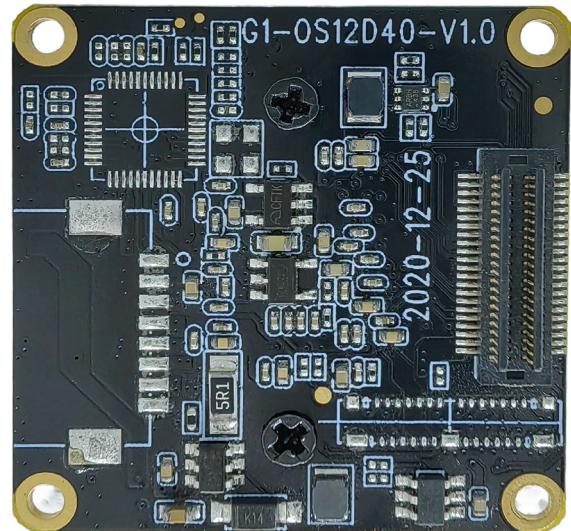

Back View

Overview

The OmniVision OS12D40 color image sensor used in the YDS-CMFL143008-OS12D40 V1.0 camera module is a high-performance CMOS 1/2.49" image sensor that can provide 11.3 megapixels (4512x2512) image signals at up to 60FPS, with a pixel size of 1.404um x 1.404um.

When used with the master board, it can support shooting 11MP high-definition images, up to 4K@60FPS (differential), and 4K@30FPS video shooting.

This camera uses board-to-board socket connection. It supports multi-axis EIS anti-shake image stabilization function. The board frame size is 32x32mm, and the size from the top of the module lens to the PCB board surface is 16.5mm.



YDS-CMFL143008-OS12D40 V1.0 11.3MP OmniVision OS12D40 Fixed Focus Camera Module

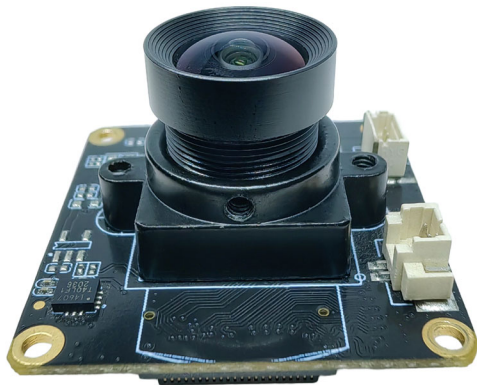



YDS-CMFL143008-OS12D40 V1.0

11.3MP OmniVision OS12D40 Fixed Focus Camera Module

Specifications

Model No.	YDS-CMFL143008-OS12D40 V1.0
Image Sensor	OS12D40
Image Sensor Type	CMOS
Effective Pixels	11.3 Megapixels
Sensor Size	1/2.49"
Pixel Size	1.404 um x 1.404 um
Video Frame Rate	4K@24/25/30/FPS, 4K@48/50/60FPS (Differential) 2.7K@24/25/30/48/50/60FPS 1080P@24/25/30/48/50/60/120FPS 720P@24/25/30/48/50/60/120/240FPS
Video Slow Motion	OFF, 4K2X, 1080P4X, 720P8X
Photo Resolution (with Master Board)	20MP (5200x3900) (Differential) 13MP (4160x3120) (Differential) 12MP (4000x3000) 10MP (3648x2736) 8MP (3264x2448) 5MP (2592x1944) 3MP (2048x1536) 2MP (1920x1080)
Operating Temperature	-10°C to +60°C
Storage Temperature	-20°C to +80°C
Humidity	20% to 80%
PCB Dimensions	32 x 32 mm
Module Size	33 x 32 x 17.5 mm
PCB Screw Hole Spacing	28 x 28 mm
PCB Screw Hole Diameter	2 mm
Lens Mount Screw Diameter	1.6 mm

YDS-CMFL143008-OS12D40 V1.0

11.3MP OmniVision OS12D40 Fixed Focus Camera Module

Lens Specifications

Lens Model No.	HX143_008
EFL (Focal Length)	2.95 mm
TTL (Total Length)	15.89 mm
F. No.	2.40
IR Coating	T=50%@650nm +/- 10nm
Lens Construction	4G3P + IR
Diagonal View Angle (DFOV)	144° (DFOV) (y' = 7.25 mm)
Horizontal View Angle (HFOV)	125° (HFOV) (y' = 6.335 mm)
Vertical View Angle (VFOV)	69° (VFOV) (y' = 3.527 mm)
Chief-Ray Angle	19°
Distortion	<-33%
Relative Illumination	>65%
Lens Operating Temperature	-20°C to +80°C
Lens Storage Temperature	-40°C to +90°C

Lens Drawing

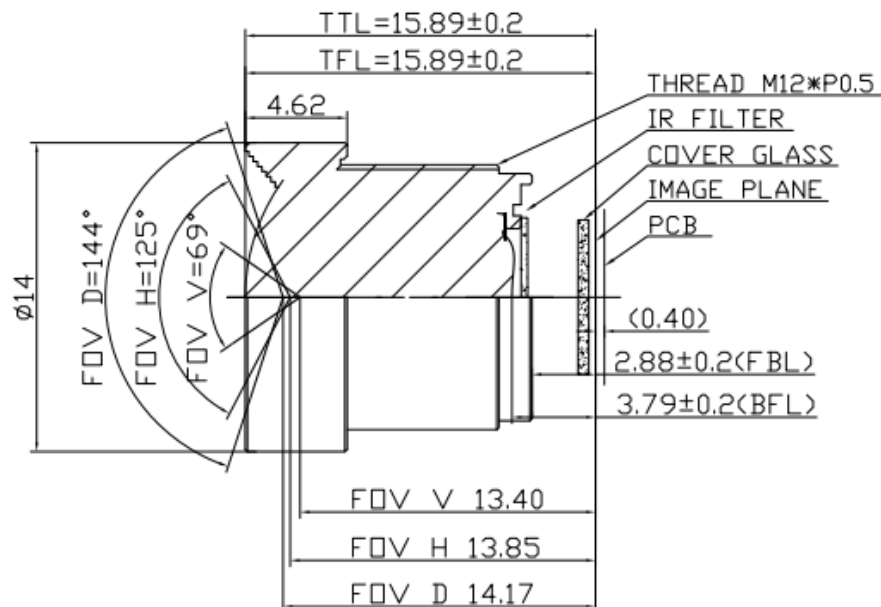

YDS-CMFL143008-OS12D40 V1.0

11.3MP OmniVision OS12D40 Fixed Focus Camera Module

陀螺仪，支持EIS防抖

EIS Stabilization

滤光片切换器接口
IR-CUT INTERFACE

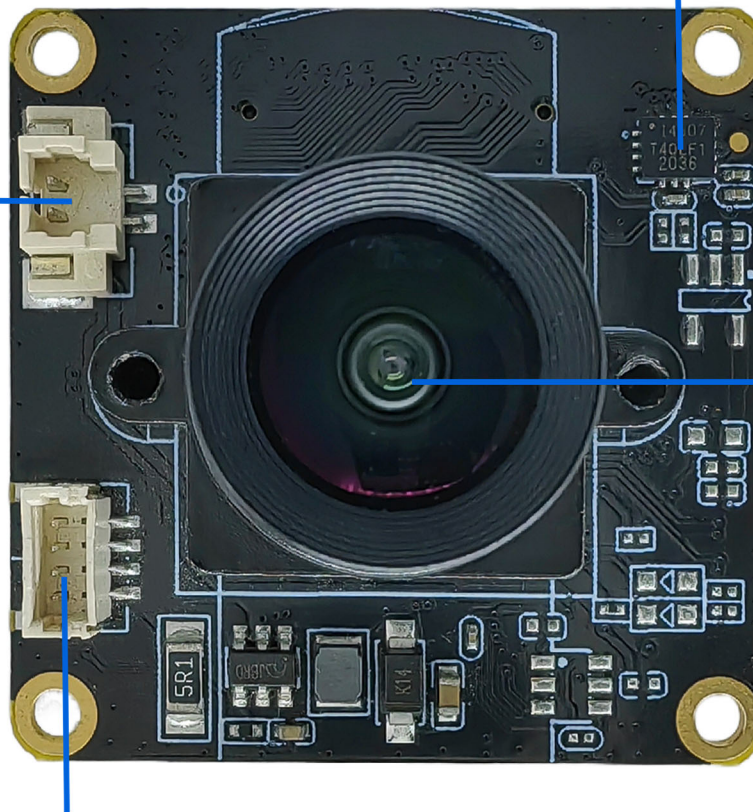

G1-OS12D40 HX143_008
V1.0 镜头模组

两组LED补光灯接口

LEDS * 2 INTERFACE

YDS-CMFL143008-OS12D40 V1.0

11.3MP OmniVision OS12D40 Fixed Focus Camera Module

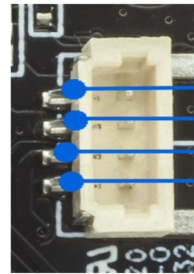
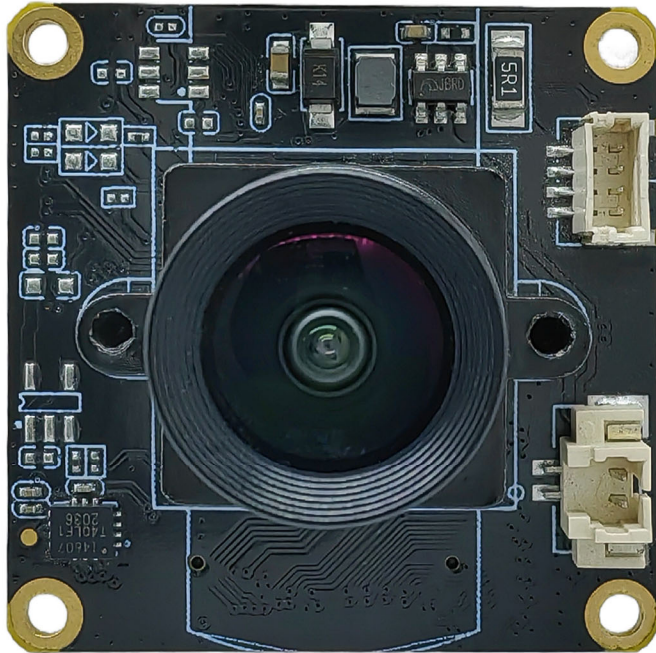

LED B -
LED B +
LED A -
LED A +

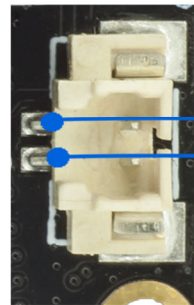

IR-CUT -
IR-CUT +

Special Note:

The two sets of fill light interfaces support the expansion of infrared light and white light boards to provide fill light for the device. If you need the fill light function, you need to add the YDS-LEDP V2.0 White and Infrared Light LED Plate.

When used with the IR cut filter lens, the infrared light can be switched automatically or manually, making videos and photos clearer at night.



YDS-CMFL143008-OS12D40 V1.0

11.3MP OmniVision OS12D40 Fixed Focus Camera Module

**通过板对板连接器连接G1主板
支持Sensor、EIS、IR-CUT、LED等**
Connect Sensor, EIS, IR-CUT, LED etc.

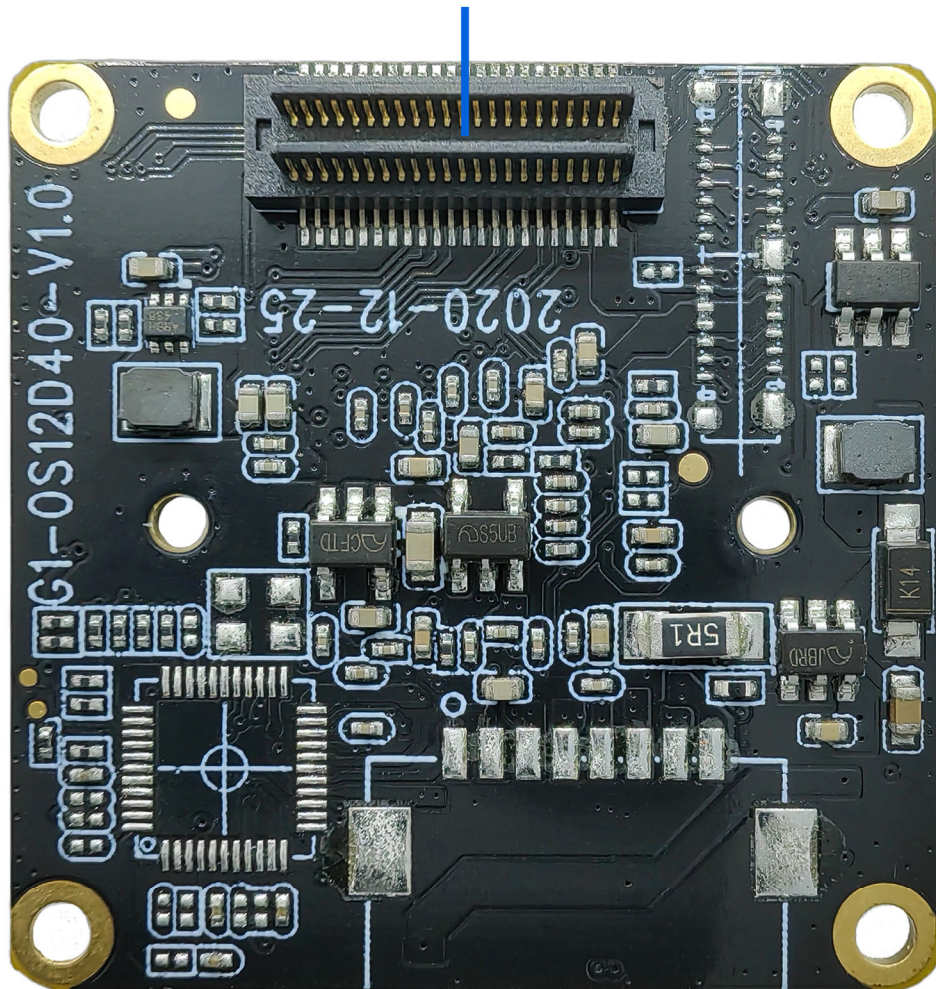

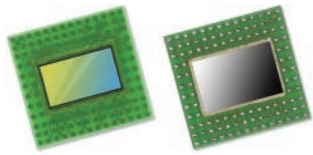

OS12D40 11.3-megapixel product brief



available in
a lead-free
package

Security Image Sensor Provides Industry-High 11.3MP Resolution for 4K2K With Electronic Image Stabilization and Best in Class HDR for 1080p Video

OmniVision's OS12D40 is a 1.4 micron pixel, 11.3MP image sensor that offers the unprecedented combination of a large 1/2.49" optical format, on-chip remosaic (4-cell to Bayer) color converter and on-chip high dynamic range (HDR) processing. It is the industry's only security sensor with 3-exposure, 4-cell HDR capability to provide larger-pixel low light performance with the best artifact elimination for moving objects. When in full-HD 1080p mode, this sensor's 3-exposure HDR with on-chip combination and tone mapping provides best in class video captures. This is superior to the competing method, known as staggered HDR, which relies on additional passes that introduce motion artifacts, especially in low light.

Integrated selective conversion gain technology allows the pixel conversion gain to be dynamically switched between low and high, depending on the scene being captured. In combination with its other features—including PureCel[®]Plus-S stacked pixel technology for reduced cross talk and maximum quantum efficiency in low light—this image sensor enables mass market security cameras to capture the industry's highest quality video and ultra wide angle photos.

The OS12D40's fast mode switch allows security operators or AI-enabled surveillance systems to seamlessly switch to 4K2K mode when a specific threat is identified for closer inspection, such as a potential intruder or unauthorized vehicle. This sensor's best in class 11.3MP resolution provides the extra pixels needed for 4K2K images with electronic image stabilization (EIS), to ensure that details can be clearly identified.

The OS12D40 is a native 16:9 aspect ratio image sensor that uses a 4-cell color filter pattern. It has an on-chip 4-cell to Bayer remosaic converter, in order to provide 4K video at 60 fps with 20% additional pixels for EIS. In a 4-cell binned mode, it can output an impressive 2.8MP/1080p resolution with 20% additional pixels for EIS video and images at four times the sensitivity. This sensor also supports both CPHY and DPHY interfaces.

Find out more at www.ovt.com.



OmniVision

Applications

- Security Cameras
- PC Multimedia
- Machine Vision

Product Features

- automatic black level calibration (ABLC)
- programmable controls for:
 - frame rate
 - mirror and flip
 - binning
 - cropping
 - windowing
- support for dynamic defect pixel cancellation (DPC)
- supports output formats: 10-bit RGB 4-cell pattern Bayer RAW
- supports horizontal and vertical subsampling
- supports typical images sizes:
 - 4512 x 2512
 - 3840 x 2160
 - 2256 x 1256
 - 1920 x 1080
 - 1280 x 720
- standard serial SCCB interface
- up to 4-lane MIPI TX interface with speed up to 2.5 Gbps/lane
- embedded 8k bits of one-time programmable (OTP) memory (4k bits reserved for customer use)
- 2/3 trio C-PHY interface, up to 1.6 Gbps/trio
- 4-cell support:
 - 4-cell binning
 - 4-cell full
- on-chip 4-cell to Bayer converter
- three on-chip phase lock loops (PLLs)
- sequential multi-frame HDR
- 2.8MP 10-bit 3-exposure 4C HDR output after tone mapping
- programmable I/O drive capability
- built-in temperature sensor
- typical module size: 8.5 x 8.5 x -5.1 mm

OS12D40



Ordering Information

- OS12D40-J08A-Z (color, lead-free)
108-pin fan-out package

Technical Specifications

- active array size: 4512 x 2512
- maximum image transfer rate:
 - 4512 x 2512: 60 fps
- power supply:
 - core: 1.1V
 - analog: 2.8V
 - I/O: 1.8V
- power requirements:
 - active: 505 mW
 - standby: <10 μ W
- temperature range:
 - operating: -30°C to +85°C junction temperature
 - stable: 0°C to +60°C junction temperature
- output formats:
 - 10-bit RGB 4-cell pattern Bayer RAW
- lens size: 1/2.49"
- lens chief ray angle: 8.7° linear
- scan mode: progressive
- pixel size: 1.404 μ m x 1.404 μ m
- image area: 6365.736 μ m x 3554.928 μ m

Functional Block Diagram

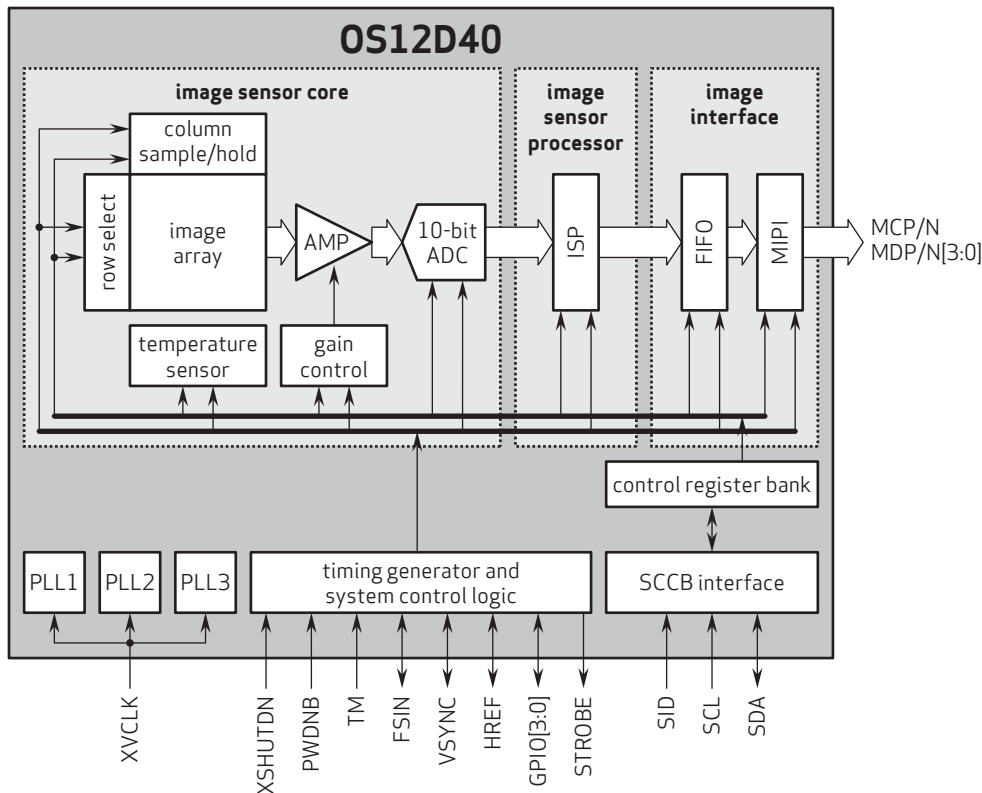

4275 Burton Drive
Santa Clara, CA 95054
USA

Tel: +1 408 567 3000
Fax: +1 408 567 3001
www.ovt.com

OmniVision reserves the right to make changes to their products or to discontinue any product or service without further notice. OmniVision, the OmniVision logo and PureCel are registered trademarks of OmniVision Technologies, Inc. All other trademarks are the property of their respective owners.



OmniVision

Cameras Applications



Automotive Driver Pilot



Live Streaming



Video Conference



Eye Tracker Biometric Detection



Machine Vision



Agricultural Monitor



Night Vision Security



Drone and Sports Eagle Eyes



Interactive Pet Camera



YDS CAMERA MODULE

your best camera partner

Camera Module Pinout Definition Reference Chart

OmniVision	Sony	Samsung	On-Semi	Aptina	Himax	GalaxyCore	PixArt	SmartSens	Sensors
Pin Signal		Description							
DGND	GND	ground for digital circuit							
AGND		ground for analog circuit							
PCLK	DCK	DVP PCLK output							
XCLR	PWDN	XSHUTDOWN	STANDBY	power down active high with internal pull-down resistor					
MCLK	XVCLK	XCLK	INCK	system input clock					
RESET	RST	reset active low with internal pull-up resistor							
NC	NULL	no connect							
SDA	SIO_D	SIOD	SCCB data						
SCL	SIO_C	SIOC	SCCB input clock						
VSYNC	XVS	FSYNC	DVP VSYNC output						
HREF	XHS	DVP HREF output							
DOVDD	power for I/O circuit								
AFVDD	power for VCM circuit								
AVDD	power for analog circuit								
DVDD	power for digital circuit								
STROBE	FSTROBE	strobe output							
FSIN	synchronize the VSYNC signal from the other sensor								
SID	SCCB last bit ID input								
ILPWM	mechanical shutter output indicator								
FREX	frame exposure / mechanical shutter								
GPIO	general purpose inputs								
SLASEL	I2C slave address select								
AFEN	CEN chip enable active high on VCM driver IC								
MIPI Interface									
MDN0	DN0	MD0N	DATA_N	DMO1N	MIPI 1st data lane negative output				
MDP0	DP0	MD0P	DATA_P	DMO1P	MIPI 1st data lane positive output				
MDN1	DN1	MD1N	DATA2_N	DMO2N	MIPI 2nd data lane negative output				
MDP1	DP1	MD1P	DATA2_P	DMO2P	MIPI 2nd data lane positive output				
MDN2	DN2	MD2N	DATA3_N	DMO3N	MIPI 3rd data lane negative output				
MDP2	DP2	MD2P	DATA3_P	DMO3P	MIPI 3rd data lane positive output				
MDN3	DN3	MD3N	DATA4_N	DMO4N	MIPI 4th data lane negative output				
MDP3	DP3	MD3P	DATA4_P	DMO4P	MIPI 4th data lane positive output				
MCN	CLKN	CLK_N	DCKN	MIPI clock negative output					
MCP	CLKP	MCP	CLK_P	DCKN	MIPI clock positive output				
DVP Parallel Interface									
D0	DO0	Y0	DVP data output port 0						
D1	DO1	Y1	DVP data output port 1						
D2	DO2	Y2	DVP data output port 2						
D3	DO3	Y3	DVP data output port 3						
D4	DO4	Y4	DVP data output port 4						
D5	DO5	Y5	DVP data output port 5						
D6	DO6	Y6	DVP data output port 6						
D7	DO7	Y7	DVP data output port 7						
D8	DO8	Y8	DVP data output port 8						
D9	DO9	Y9	DVP data output port 9						
D10	DO10	Y10	DVP data output port 10						
D11	DO11	Y11	DVP data output port 11						

www.YDSCAM.com sales@ydscam.com Phone (WeChat, QQ): (+86) 177 2732 6718

All rights reserved @ YingDeShun Co. Ltd. Specifications subject to change without notice.

Camera Reliability Test

Reliability Inspection Item		Testing Method	Acceptance Criteria	
Category	Item			
Environmental	Storage Temperature	High 60°C 96 Hours	Temperature Chamber	No Abnormal Situation
		Low -20°C 96 Hours	Temperature Chamber	No Abnormal Situation
	Operation Temperature	High 60°C 24 Hours	Temperature Chamber	No Abnormal Situation
		Low -20°C 24 Hours	Temperature Chamber	No Abnormal Situation
	Humidity	60°C 80% 24 Hours	Temperature Chamber	No Abnormal Situation
	Thermal Shock	High 60°C 0.5 Hours Low -20°C 0.5 Hours Cycling in 24 Hours	Temperature Chamber	No Abnormal Situation
Physical	Drop Test (Free Falling)	Without Package 60cm	10 Times on Wood Floor	Electrically Functional
		With Package 60cm	10 Times on Wood Floor	Electrically Functional
	Vibration Test	50Hz X-Axis 2mm 30min	Vibration Table	Electrically Functional
		50Hz Y-Axis 2mm 30min	Vibration Table	Electrically Functional
		50Hz Z-Axis 2mm 30min	Vibration Table	Electrically Functional
	Cable Tensile Strength Test	Loading Weight 4 kg 60 Seconds Cycling in 24 Hours	Tensile Testing Machine	Electrically Functional
Electrical	ESD Test	Contact Discharge 2 KV	ESD Testing Machine	Electrically Functional
		Air Discharge 4 KV	ESD Testing Machine	Electrically Functional
	Aging Test	On/Off 30 Seconds Cycling in 24 Hours	Power Switch	Electrically Functional
	USB Connector	On/Off 250 Times	Plug and Unplug	Electrically Functional



Camera Inspection Standard

Inspection Item		Inspection Method	Standard of Inspection	
Category	Item			
Appearance	FPC/ PCB	Color	The Naked Eye	Major Difference is Not Allowed.
		Be Torn/Chopped	The Naked Eye	Copper Crack Exposure is Not Allowed.
		Marking	The Naked Eye	Clear, Recognizable (Within 30cm Distance)
	Holder	Scratches	The Naked Eye	The Inside Crack Exposure is Not Allowed
		Gap	The Naked Eye	Meet the Height Standard
		Screw	The Naked Eye	Make Sure Screws Are Presented (If Any)
		Damage	The Naked Eye	The Inside Crack Exposure is Not Allowed
	Lens	Scratch	The Naked Eye	No Effect On Resolution Standard
		Contamination	The Naked Eye	No Effect On Resolution Standard
		Oil Film	The Naked Eye	No Effect On Resolution Standard
		Cover Tape	The Naked Eye	No Issue On Appearance.
	Function	Image	No Communication	Test Board
Bright Pixel			Black Board	Not Allowed In the Image Center
Dark Pixel			White board	Not Allowed In the Image Center
Blurry			The Naked Eye	Not Allowed
No Image			The Naked Eye	Not Allowed
Vertical Line			The Naked Eye	Not Allowed
Horizontal Line			The Naked Eye	Not Allowed
Light Leakage			The Naked Eye	Not Allowed
Blinking Image			The Naked Eye	Not Allowed
Bruise			Inspection Jig	Not Allowed
Resolution			Chart	Follows Outgoing Inspection Chart Standard
Color			The Naked Eye	No Issue
Noise			The Naked Eye	Not Allowed
Corner Dark			The Naked Eye	Less Than 100px By 100px
Color Resolution			The Naked Eye	No Issue
Dimension	Height	The Naked Eye	Follows Approval Data Sheet	
	Width	The Naked Eye	Follows Approval Data Sheet	
	Length	The Naked Eye	Follows Approval Data Sheet	
	Overall	The Naked Eye	Follows Approval Data Sheet	

YDSCAM Package Solutions

YDS Camera Module



Complete with Lens Protection Film



Tray with Grid and Space



Place Cameras on the Tray



YDSCAM Package Solutions

Full Tray of Cameras



Cover Tray with Lid



Place Tray into Anti-Static Bag



Vacuum the Anti-Static Bag



YDSCAM Package Solutions

Sealed Vacuum Anti-Static Bag with Labels

1. Model and Description 2. Quantity 3. Manufacturing Date Code 4. Caution



YDSCAM Package Solutions

Place Foam Sheets Between Tray Bags



Foam Sheets are Larger Than Trays



Place Foam Sheets and Trays into Box



Foam Sheets are Tightly Fitting in Box



Seal the Carbon Box



Label the Carbon Shipping Box





YDSCAM Package Solutions

USB Camera Module

Complete with Lens Protection Film



Place Camera Sample into Anti-Static Bag

Place USB Cameras into Tray



Seal the Tray with Anti-Static Bag

Label the Carbon Shipping Box



YDSCAM Package Solutions

Place Camera Sample into Anti-Static Bag



Place Connectors into Anti-Static Bag



Label the Sample Bags



Place Connectors into Reel



Place Samples into the Carbon Box



Place Connectors into the Carbon Box





YDS CAMERA MODULE

your best camera partner

Company YDSCAM

YingDeShun Co. Ltd. (YDS) was established in 2017, a next-generation technology driven manufacturer specialized in research, design, and produce of audio and video products. YDS is occupying 20,000 square feet automated plants with 100 employees of annual throughput 30,000,000 units cameras.

YDS provides OEM, ODM design, contract manufacturing, and builds the camera products. You may provide the requirements to us, even with a hand draft, our sales and engineering work together to meet your needs. We consider ourselves your last-term partner in developing practical and innovative solutions.

Our team covers everything from initial concept development to mass produced product. YDS specializes in customized camera design, raw material, electronic engineering, firmware/software development, product testing, and packing design. Our experienced strategic supply systems offer a robust and dependable manufacturing capacity for orders of various sizes.



Limited Warranty

YDS provides the following limited warranty if you purchased the Product(s) directly from YDS company or from YDS's website www.YDSCAM.com. Product(s) purchased from other sellers or sources are not covered by this Limited Warranty. YDS guarantees that the Product(s) will be free from defects in materials and workmanship under normal use for a period of one (1) year from the date you receive the product ("Warranty Period").

For all Product(s) that contain or develop material defects in materials or workmanship during the Warranty Period, YDS will, at its sole option, either: (i) repair the Product(s); (ii) replace the Product(s) with a new or refurbished Product(s) (replacement Product(s) being of identical model or functional equivalent); or (iii) provide you a refund of the price you paid for the Product(s).

This Limited Warranty of YDS is solely limited to repair and/or replacement on the terms set forth above. YDS is not reliable or responsible for any subsequent events.



www.YDSCAM.com sales@ydscam.com Phone (WeChat, QQ): (+86) 177 2732 6718

All rights reserved @ YingDeShun Co. Ltd. Specifications subject to change without notice.



YDS CAMERA MODULE

your best camera partner

YDS Strength

Powerful Factory



Professional Service



Promised Delivery



www.YDSCAM.com sales@ydscam.com Phone (WeChat, QQ): (+86) 177 2732 6718

All rights reserved @ YingDeShun Co. Ltd. Specifications subject to change without notice.